



SAC2

User Guide

Super Analog Controller - 2 channel



The Future of Sound. Made Perfectly Clear.

At KV2 Audio our vision is to constantly develop technologies that eliminate distortion and loss of information providing a true dynamic representation of the source.

Our aim is to create audio products that absorb you, place you within the performance and deliver a listening experience beyond expectations.

Important safety instructions

Before using your SAC2, be sure to carefully read the applicable items of these operating instructions and the safety suggestions.

1. Read all product instructions.
2. Keep printed instructions, do not throw away.
3. Respect and review all warnings.
4. Follow all instructions.
5. Do not use this unit near water, in unprotected out door areas or in rain or wet conditions.
6. Clean only with dry cloth.
7. Do not block any ventilation openings.
8. Install in accordance with KV2 Audio's recommended installation instructions.
9. Do not install near any heat sources such as heat radiators, heat registers, stoves or other apparatus that produce heat.
10. Do not defeat the safety purpose of the grounding type plug. A grounding type plug has two blades and a third grounding connector. The third connector is provided for your safety. If the provided plug does not fit into your outlet, consult an electrician for replacement of the obsolete outlet.
11. Protect the power cord from being walked on or pinched, particularly at plugs, convenience receptacles and the point where they exit from the SAC2. The AC mains plug or appliance coupler shall remain readily accessible for operation.
12. Only use accessories specified by KV2 Audio.
13. The unit is intended for use in a 19" rack. Follow the mounting instructions.
14. Unplug SAC2 during lightning storms or when unused for long periods of time.
15. Refer all servicing to qualified service personnel. Servicing is required when the SAC2 has been damaged in any way, such as when the power-supply cord or plug has been damaged; liquid has been spilled or objects have fallen into the SAC2; rain or moisture has entered the SAC2; the SAC2 has been dropped; or when for undetermined reasons the SAC2 does not operate normally.
16. Do not remove top or bottom covers. Removal of the cover will expose hazardous voltages. There are no user serviceable parts inside and removable may void the warranty.
17. An experienced user shall always supervise this professional audio equipment.

**CAUTION: TO REDUCE THE RISK OF ELECTRIC SHOCK, DO NOT REMOVE THE COVER.
NO USER-SERVICEABLE PARTS INSIDE. REFER SERVICING TO QUALIFIED PERSONNEL.**

WARNING: To prevent fire or electric shock, do not expose this equipment to rain or moisture.

Contents

Introduction	3
Introduction	3
Dimensions	3
Getting Started	4
Unpacking	4
Rack mounting	4
AC Power requirements	4
Voltage requirements	4
Connector wiring	4
Features	5
Front Panel	5 - 6
Rear Panel	7
Using the System	8
Stereo Master EQ	8
2-Way Stereo Crossover	9
2-Way Stereo Crossover with mono Subwoofer	10
Block Diagram	11
Input Cables and Output Cables	12
Specifications	13
Warranty · Service	14
Notes	15 - 16

SAC2

SAC2 - part number KVV 987 228 (230V)
KVV 987 229 (115V)



Application

Designed as an active crossover – equalizer - limiter and controller for the ESD range with superior sound quality

- Fixed Installations
- Portable PA
- Speaker protection and level control
- Use with any KV2 Audio system as a FOH EQ or with any alternative systems

Introduction

The SAC2 is a 2 input x 4 output audio controller designed for use with KV2 audio passive and active loudspeakers as well as third party systems. The SAC2 serves as a 2-way stereo crossover, Master EQ, leveller / limiter, or a combination of all three.

The fixed crossover points of either 70Hz or 120Hz can be selected for standard 2 x 2 way configuration, whilst both Low and High outputs can be independently switched into direct mode, allowing combined crossover, overlap and full range operation. The Low section also features a special Sub EQ low frequency enhancement circuit that can be switched in or out as desired.

The SAC2's main advantage is its very high audio quality using only KV2 Audio's new Super Analog technology. The limiter / leveller is a sophisticated circuit operating in a way that stops the maximum level being exceeded but without the overall operating level but operators still require the highest quality audio performance. The master equalisation section features a new Super Analog four band equalisation circuit across the stereo channels as well feedback issues.

For the best performance where possible use only KV2 Audio components, any other component may negatively affect the sound quality.

Dimensions

Front Panel:

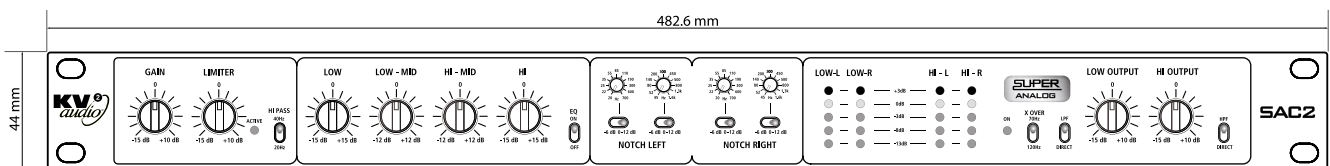

Rear Panel:

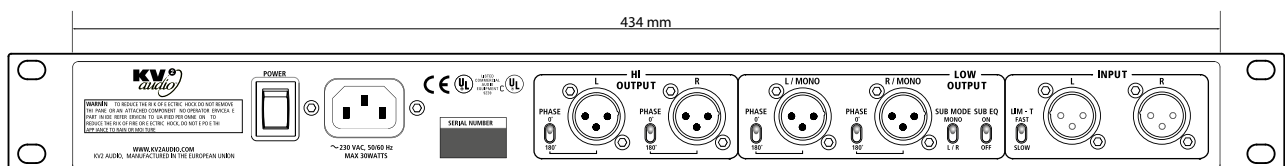

Side Panel:

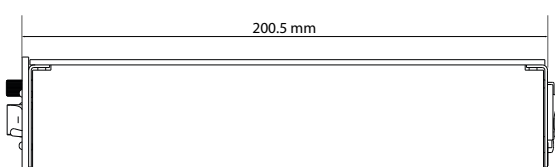

SAC2 · Introduction

Unpacking

Unpack the SAC2 and check to see if there is any damage to it. If you find any damage notify your supplier immediately. Only the consignee may institute a claim with the carrier for any damage incurred during shipping. Be sure to save the carton and all packaging materials for the carrier's inspection.

Should you ever need to ship the unit, only use the original factory packaging. If the shipping carton is unavailable, contact your supplier to obtain a replacement.

The SAC2 carton should contain:

- SAC2 Super Analogue Controller
- User's Guide
- IEC Power Cable

Rack mounting

The SAC2 will mount in a standard 19" rack system. Use four screws and washers to mount the SAC2 to the rack rails. We recommend using a shock-mounted rack for touring use to prolong the life of your SAC2.

To prevent accidental adjustment of settings, or unwanted tampering in a fixed installation, KV2 Audio provide an additional security panel.

AC Power requirements

The SAC2 uses a standard IEC 3-pole AC connector. The device must be connected to a mains socket outlet with protective earthing connection. The SAC2 operates in either 115V or 230V mode. This setup is preconfigured at the factory. The mains plug of the power supply cord shall remain readily operable.

Voltage requirements

The SAC2 operates safely and without audio discontinuity if the AC voltage stays within the operating window of 90V-130V in 115V mode or 180V-260V when working in 230V mode at 50 or 60Hz.

CAUTION: IF THE ON LED DOES NOT ILLUMINATE OR THE SYSTEM DOES NOT RESPOND TO AUDIO INPUT REMOVE AC POWER IMMEDIATELY. VERIFY THAT THE VOLTAGE IS WITHIN THE PROPER RANGE. IF THE PROBLEM PERSISTS, PLEASE CONTACT KV2 AUDIO OR AN AUTHORIZED SERVICE CENTER.

Connector wiring

XLR Balanced Input and Output connectors

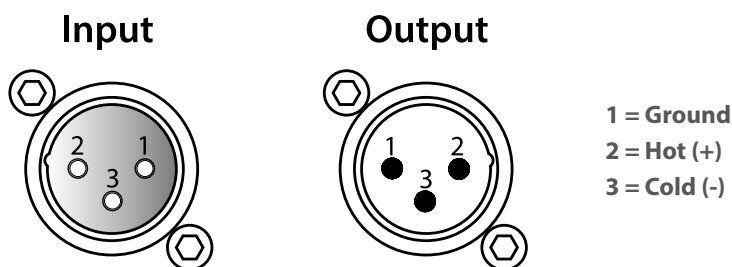

CAUTION: IF IT IS NECESSARY TO CONVERT BALANCED OUTPUT TO UNBALANCED, IT IS IMPOSSIBLE TO SHORT HOT(2) OR COLD(3) PINS WITH GROUND(1). IN THIS EVENT THE LINE DRIVERS WILL CAUSE PERMANENT DISCONNECTION.

Front Panel

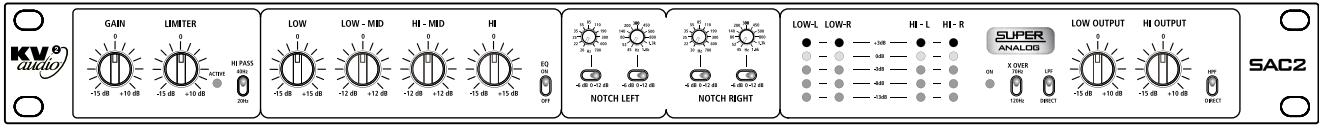

Gain

Adjusts the SAC2's input levels from -15dB to +10dB.

Limiter

Adjusts the maximum output level. When this level is exceeded, the limiter reduces the signal to the desired level according to your setting.

The Limiter ensures that this level is not exceeded whilst maintaining the dynamics and signal quality.

A switch by the input connector allows the user to adjust the limiter time (fast or slow). It adjusts the attack and decay together.

The Limiter level can be adjusted from -15dB to +10dB.

The Limiter function is indicated by Active LED.

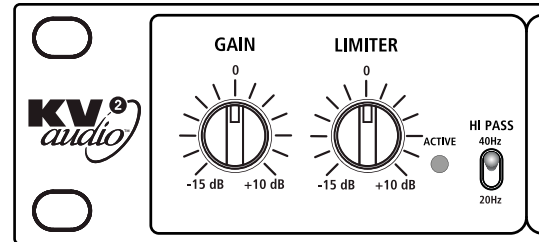

High Pass Filter

This switch selects between either a 20Hz or 40Hz high pass filter. It has a slope of 12dB/octave and it is used to protect your subwoofer system from the frequencies that it cannot reproduce efficiently and may cause damage.

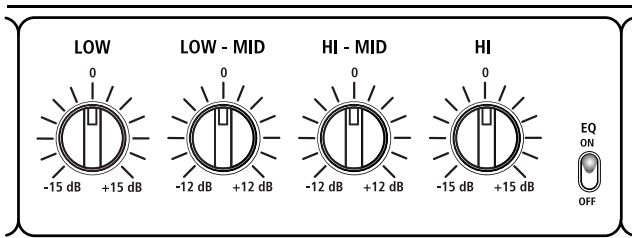

Four-Band Equalizer

The four-band EQ section is a unique Super Analog equalization circuit specially designed to highlight the desired band without adversely affecting the overall sound.

- Low** • Boosts or cuts Low frequencies around 20Hz by +/-15dB
- Low-Mid** • Boosts or cuts Low-Mid frequencies around 450Hz by +/-12dB
- Hi-Mid** • Boosts or cuts Low-Mid frequencies around 2.5kHz by +/-12dB
- Hi** • Boosts or cuts Hi frequencies around 18kHz by +/-15dB

Notch Filters

Use independent left and right notch filters to quickly and effectively reduce room resonances and feedback issues. Three position level switch, -6dB (left), Bypass (middle) and -12dB (right). The potentiometers should be used to find and tune out any problem frequencies.

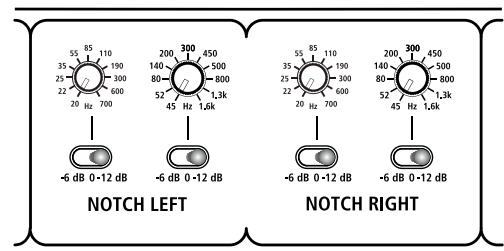

Front Panel

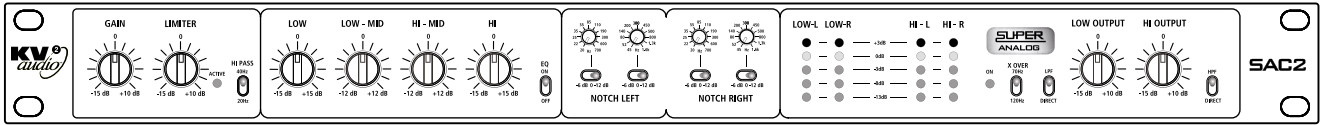

Output level bar graph indicators

The levels of each individual output are indicated with LED bar graphs.

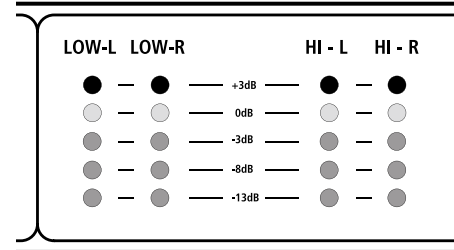

Power On LED

Indicates whether the SAC2 is powered on.

Crossover frequency

The "X OVER" switch allows users to select a crossover frequency of either 70Hz or 120Hz. The correct frequency selection depends on the individual characteristics of the speakers used.

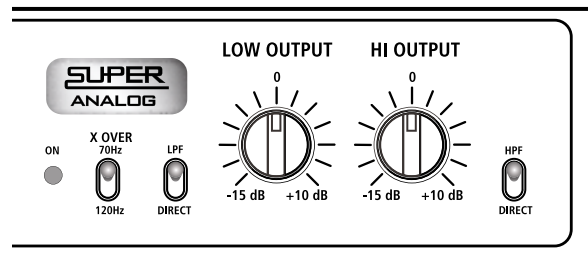

LPF / Direct switch

The crossover's Low Pass Filter can be bypassed by switching to the DIRECT position allowing a full range signal to pass through the low outputs.

Low output

Adjusts the LOW OUTPUT levels from -15dB to +10dB.

High Output

Adjusts the HIGH OUTPUT levels from -15dB to +10dB.

HPF / Direct switch

The crossover's High Pass Filter can be bypassed by switching to the DIRECT position allowing a full range signal to pass through the high outputs.

Rear Panel

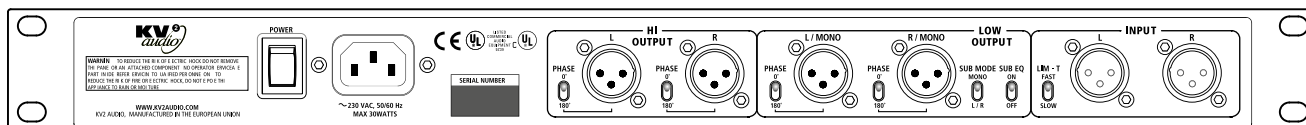

Input

Balanced Female XLR connectors for connecting Left and Right audio signal.

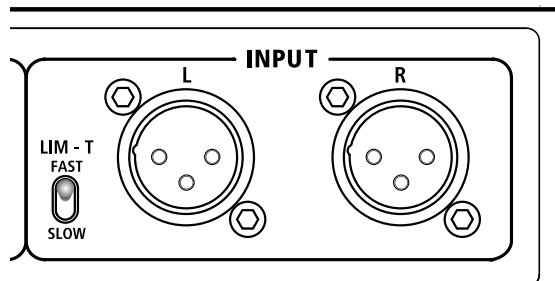

Limiter time switch

The "LIM-T" switch adjusts the limiter time between either fast or slow, adjusting the attack and decay at the same time

Low Output

Balanced Male XLR connectors for sending Left and Right low frequency audio signal.

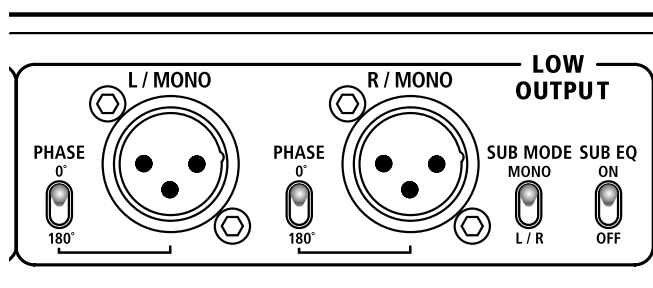

Phase Switches

These switches reverse the polarity of the low frequency output signal.

Sub Mode

This switch is used to switch the Low Output mode between Mono and Stereo. In Mono mode both low outputs are summed together and both low outputs produce the same signal. Mono mode is active only if LPF / Direct switch is set to LPF.

Sub EQ

This switch turns on the low frequency enhancement circuitry which boosts frequencies around 60Hz to enhance the lowest frequency band. This also works in full range mode (LPF off) to provide a bass enhancement to a full range signal.

Hi Output

Balanced Male XLR connectors for sending Left and Right high frequency audio signal.

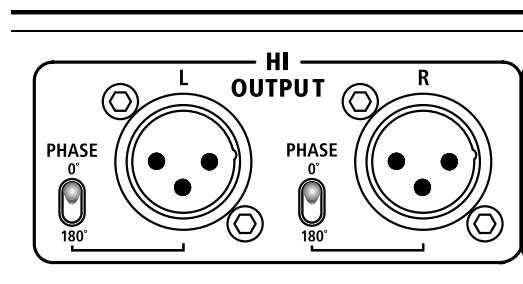

Phase Switch

These switches reverse the polarity of the high frequency band output signal.

Power Switch

Used to turn the SAC2 on or off.

Plug power connector

For connection to a standard IEC 3-pole AC connector. Before connecting make sure that the mains voltage corresponds to the SAC2's voltage requirements as stated on the unit.

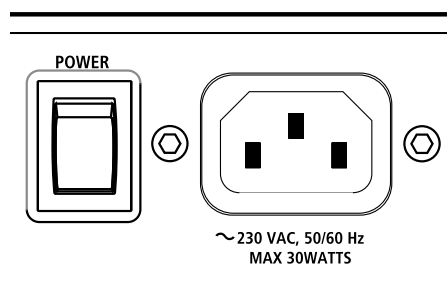

Stereo Master EQ

One of the advantages of the SAC2 is the ability to use the Notch Filters and four-band EQ as both a Master and Monitor/Fill EQ. The Low Output can be used to send a full-range PA signal by switching it to DIRECT mode. The Hi Output can be used to send a full-range signal by switching it to DIRECT mode or as a High Pass Filter with selectable 70Hz or 120Hz frequency to send signal to Monitor/Fill loudspeakers. The built in VHD Line Drivers ensure the highest possible signal integrity over long distances.

L - Full Range PA

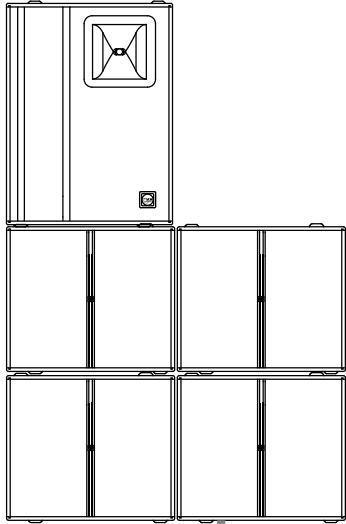

R - Full Range PA

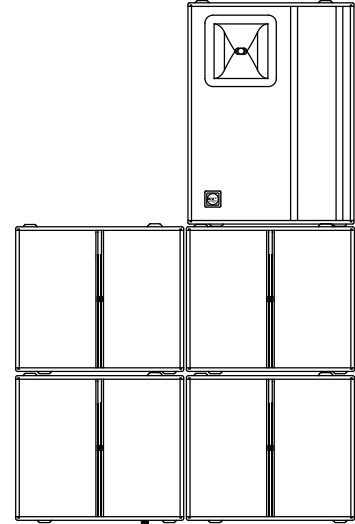

L - Fill in

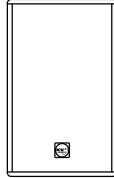

R - Fill in

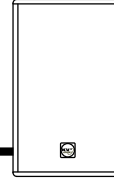

L-Hi Out

R-Hi Out

L-Full range Out

R-Full range Out

SAC2 Rear view

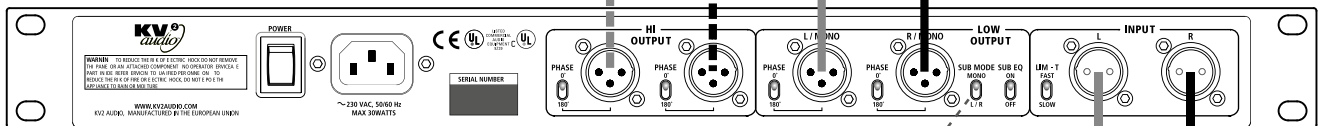

SAC2 Front view

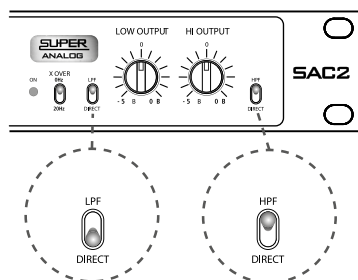

L-Full range In

R-Full range In

2-Way Stereo Crossover

The primary function of the SAC2 is as a 2-way stereo crossover.

The Low Output is used as a stereo low pass signal for subwoofers. The Low Output should be switched to LPF and the Left and Right outputs sent to the subwoofers.

The Hi Output is used as a stereo high pass signal for mid/hi loudspeakers. The Hi Output should be switched to HPF and the Left and Right outputs sent to the mid/hi loudspeakers.

The built in VHD Line Drivers ensure the highest possible signal integrity over long distances.

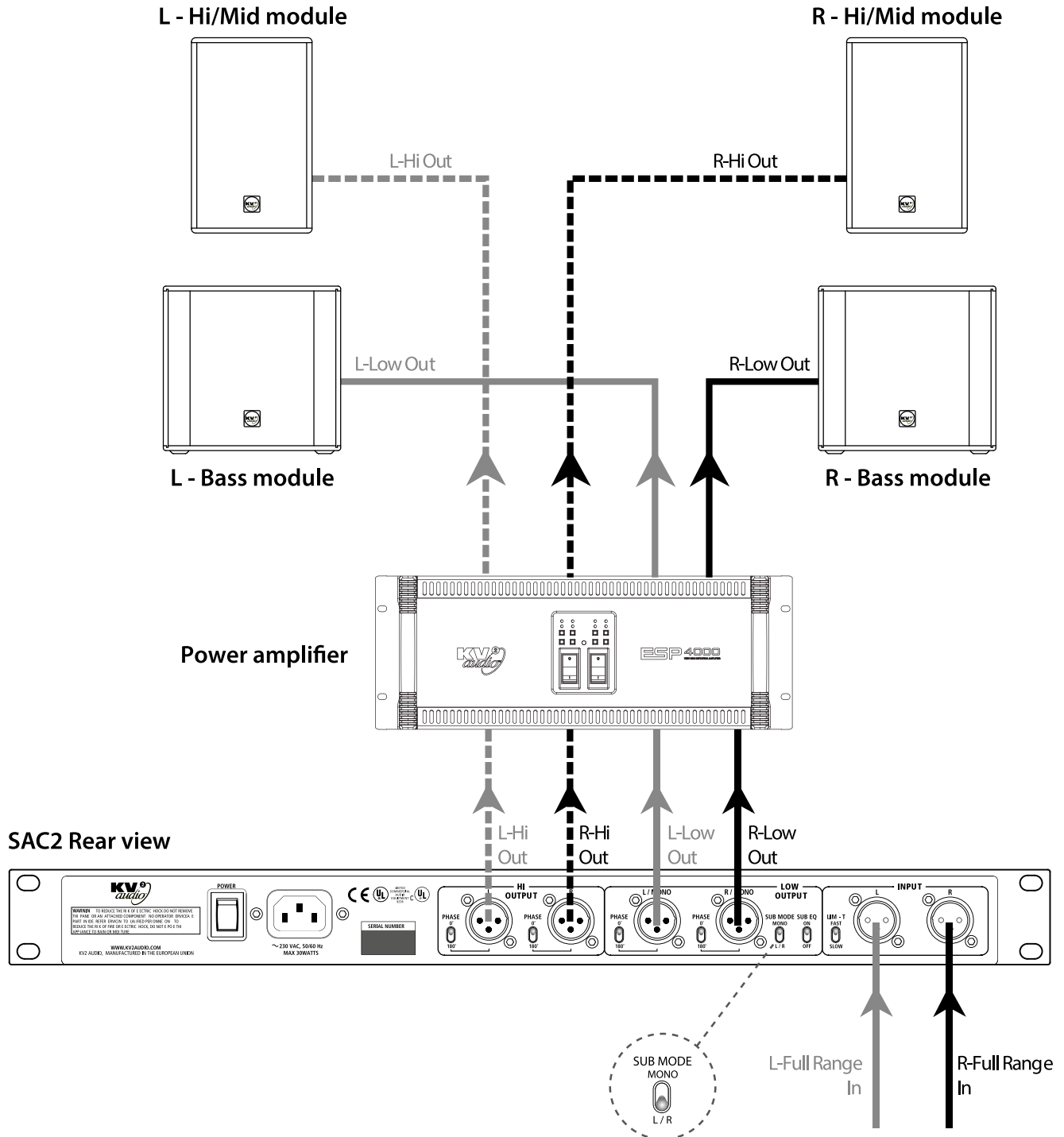

SAC2 · Using the System

SAC2 · Block Diagram



Left channel

Right channel is identical

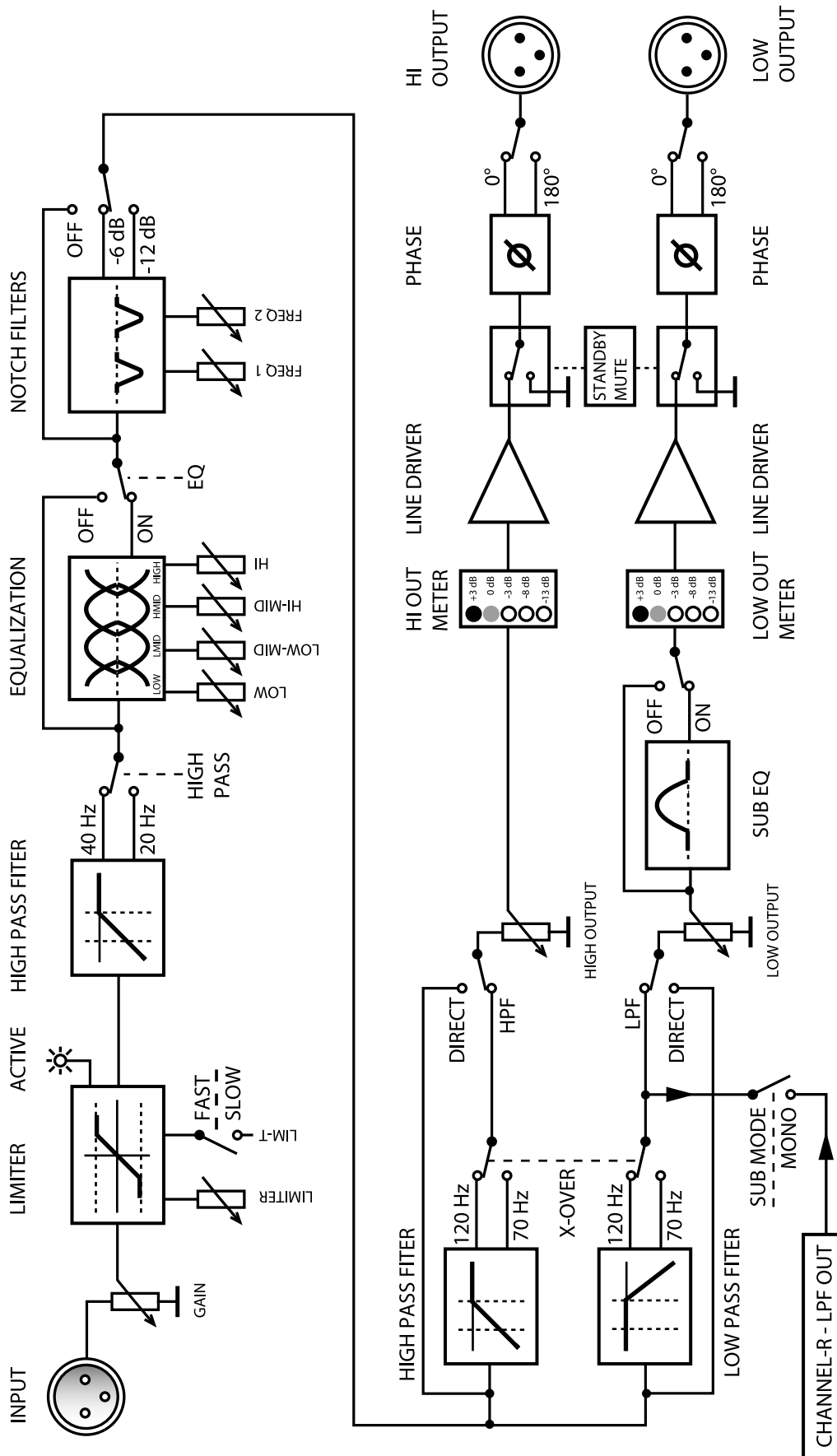

Input Cables and Output Cables

SAC2 Input Cables

XLR output - XLR input

- Pin 2 - Pin 2 (Hot)
- Pin 3 - Pin 3 (Cold)
- Pin 1 - Pin 1 (Shield)

Female Plug

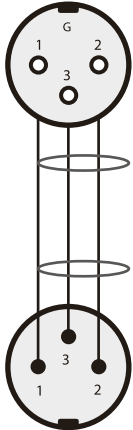

Male Plug
to SAC2 Input

Jack output (balanced) - XLR input

- Tip - Pin 2 (Hot)
- Ring - Pin 3 (Cold)
- Sleeve - Pin 1 (Shield)

TRS (Stereo) Jack

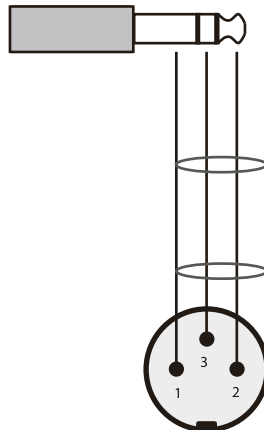

Male Plug
to SAC2 Input

Jack output (unbalanced) - XLR input

- Tip - Pin 2 (Signal)
- Sleeve - Pin 3 (Shield)
- Sleeve - Pin 1 (Shield)

(Mono) Jack

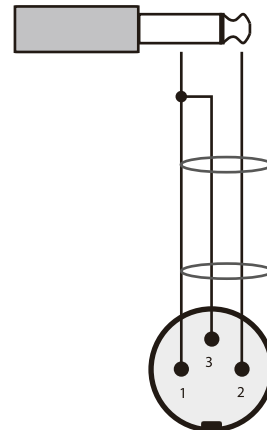

Male Plug
to SAC2 Input

SAC2 Output Cables

XLR output - XLR input

- Pin 2 - Pin 2 (Hot)
- Pin 3 - Pin 3 (Cold)
- Pin 1 - Pin 1 (Shield)

from SAC2 Output
SAC2 Female Plug

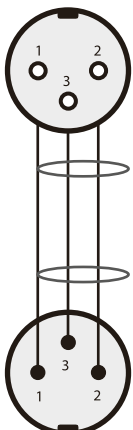

Male Plug

XLR output - Jack input (balanced)

- Pin 2 - Tip (Hot)
- Pin 3 - Ring (Cold)
- Pin 1 - Sleeve (Shield)

from SAC2 Output
SAC2 Female Plug

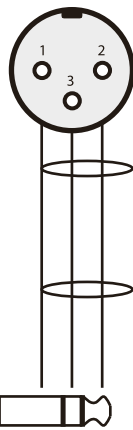

TRS (Stereo) Jack

XLR output - Jack input (unbalanced)

- Pin 2 - Tip (Signal)
- Pin 3 - No Connection
- Pin 1 - Sleeve (Shield)

from SAC2 Output
SAC2 Female Plug

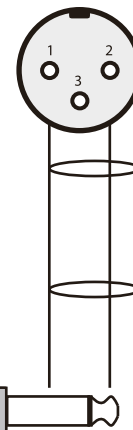

TRS (Stereo) Jack

XLR Plugs seen from solder side

Specifications

System Acoustic Performance	
-1dB Response	20Hz to 40kHz
Dynamic Range	>115dB
Channel Crosstalk	>60dB
Total Harmonic Distortion	<0.005%
Output Channels	
Max. Output Voltage	14V / 7V (50Ω) RMS
Max. Output Current	450mA
Signal Input	
Input Channels	2
Input Impedance	20kΩ (balanced)
Line input	XLR
Signal Output	
Output Channels	4 x Line Driver
Output Impedance	50Ω
Features	
Level Control	-15 / +10dB
System setup	Crossover / Bypass
Gain	-10 / +10dB
Phase	0° / 180°
Crossover	70 / 120Hz, Butterworth 12dB /octave
High Pass Filter	20 / 40Hz
Equalization	4-band equalizer
Notch Filter	2 per channel
Loudness bass enhancement	+6dB @ 60Hz
Volume Limiter	Fast/Slow / -15 + 10dB
Indicators	4x LED bar graphs
Power	
Power Connector	IEC 320
Operating Voltage	115V / 230V
Operating Voltage Range	90 to 130V@60Hz 180 to 260V@50Hz
Physical Dimensions	
Height	44 mm (1.73")
Width	482.6 mm (19.0")
Depth	200.5 mm (7.9")
Weight	3.2 kg (7.05lbs)

Warranty

Your SAC2 is covered against defects in material and workmanship.

Refer to your supplier for more details.

Service

In the unlikely event that your SAC2 develops a problem, it must be returned to an authorized distributor, service centre or shipped directly to our factory. Because of the complexity of the design and the risk of electrical shock, all repairs must be attempted only by qualified technical personnel.

If the unit needs to be shipped back to the factory, it must be sent in its original carton. If improperly packed, the unit may be damaged.

To obtain service, contact your nearest KV2 Audio Service Centre, Distributor or Dealer.



The Future of Sound.
Made Perfectly Clear.

KV2 Audio International

Nádražní 936, 399 01 Milevsko
Czech Republic

Tel.: +420 383 809 320

Email: info@kv2audio.com

www.kv2audio.com

KVV120062-00-05-0